

SS15A3P

Generator Automatic Voltage Regulator Operation Manual

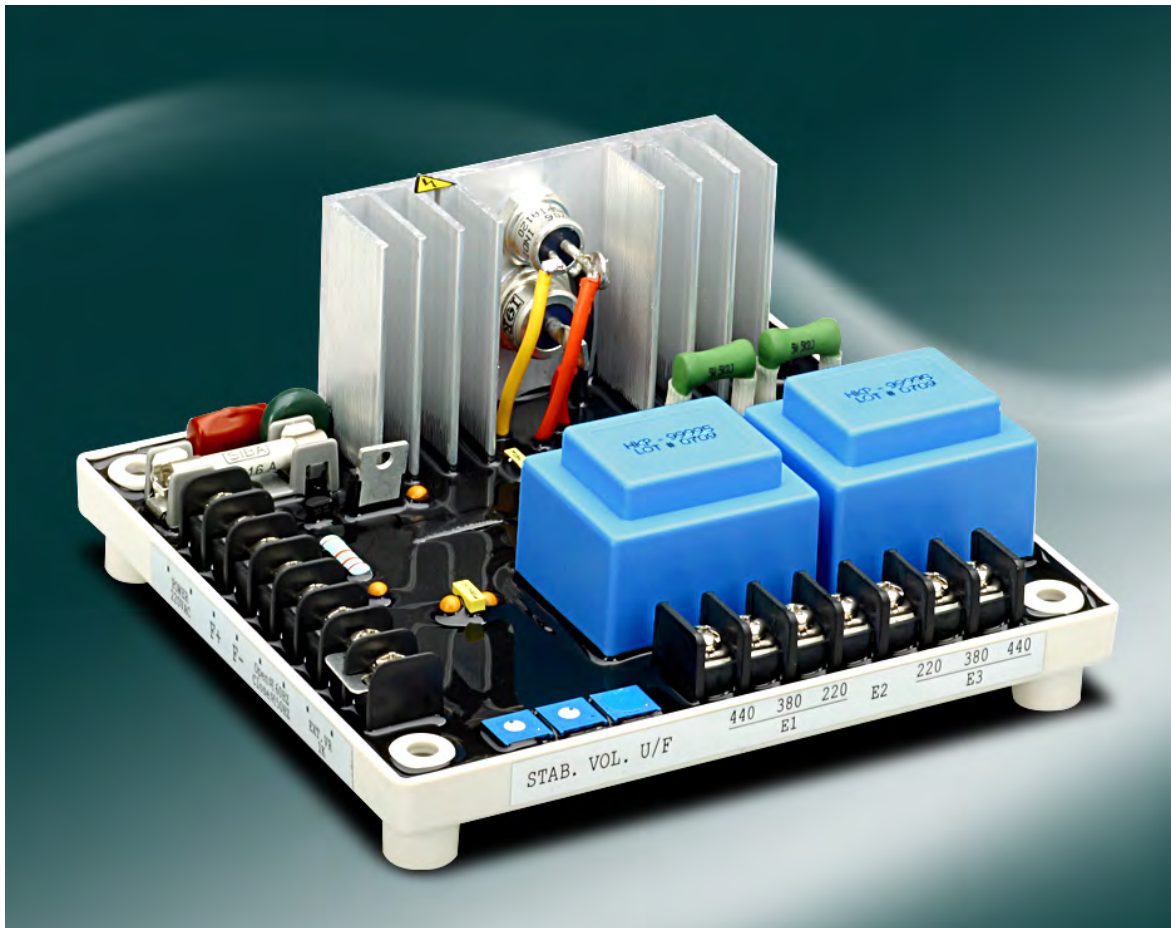

Self Excited Automatic Voltage Regulator 15 Amp 3 Phase Sensing AVR

1. INTRODUCTION

Sensing Input

Voltage 180 ~ 500 VAC, 3 phase 3 wire
Frequency 50 / 60 Hz, selectable

Power Input

Voltage 100 ~ 300 VAC, 1 phase 2 wire

Output

Voltage Max. 90 VDC @ 240 VAC input
Current Continuous 15A
Intermittent 20A for 10 sec
Resistance Min. 9 ohm

Voltage Regulation

< ± 0.5% (with 4% engine governing)

Voltage Build-up

Residual voltage at AVR terminal > 5 VAC

Thermal Drift

0.03% per °C change in AVR ambient

External Volts Adjustment

± 15% with 1K ohm 1 watt trimmer

Unit Power Dissipation

Max. 8 watt

Under Frequency Protection (Factory Setting)

60 Hz system presets knee point at 55 Hz
50 Hz system presets knee point at 45 Hz

Soft Start Ramp Time

2 sec.

Dimensions

150mm L * 135mm W * 72mm H

Weight

867 g ± 2%

2. WIRING (Refer to Fig4, Fig5)

2.1 Terminals F+ & F -

- fi The DC output port of the regulator
- fi F+ is positive normally connected to the field of generator marked 'F+', 'F1' or 'J'
- fi F- is negative normally connected to the field of generator marked 'F-', 'F2' or 'K'

2.2 Terminals sensing

- fi The power and sensing port of the regulator (Sensing voltage had been connected on 220 / 380 / 440 / 480V three phase from generator)
- fi Single phase will cause output voltage 27% exceed nominal value

2.3 Terminals EXT VR.

- fi For external voltage adjustment if required.

2.4 Terminals 50 & COM

- fi Under frequency protection selection
- fi Connect a jumper from COM to the 50Hz terminal for 50 Hz operation, or leave the two terminals unconnected for 60Hz operation.

3. NOTICE OF USE

The SS15A3P can be mounted in various place, like generator control panel, switchgear cabinets, ect. But prevent high temperature, high moisture, or severe vibration places.

See figure 1 for mounting dimensions.

The EA15A3H surface temperature will be over 60°C when operations. DO not touch the heat sink.

3.1 Startup Procedure

1. Ensure all the wire of the regulator are correctly connected and the proper fuse (15A500V) is installed.
2. Turn voltage potentiometer full anticlockwise (lowest voltage level).
3. If used, turn external voltage potentiometer to the middle position.
4. Turn stability potentiometer full clockwise (highest stability level).
5. Connect a 110VDC meter across the field with proper polarity.

6. Connect a 300VAC meter across line to neutral of generator.
7. Start and run the generator at no load and rated speed.

The generator output voltage should build up to a minimum level if the voltage does not build up, it may cause by low residual voltage of generator. Refer to field flashing section in generator manual.

8. Slowly adjust voltage potentiometer until the generator voltage reach the proper value.
9. Turn the stability potentiometer clockwise until instability is shown, and then turn it anticlockwise slightly still both meter mention in (5) and (6) shown stable.
10. Interrupt regulator power for a short time (approximately 1 to 2 second). If the voltage still stable, the adjustment is now completed. Otherwise increase the stability slightly, repeat procedure (10) until stability is reached.

4. ADJUSTMENTS

4.1 Frequency Roll-Off Adjustment

Connect a jumper from COM to the 50Hz terminal for 50Hz operation, or leave the two terminal unconnected for 60Hz operation. To reset the frequency roll-off, proceed as follow :

1. Adjust the prime mover RPM to the desired frequency compensation (corner frequency roll-off) point.
2. Adjust the front panel FREQ control until the output voltage low about 5V than nominal voltage. (For 50Hz applications, the frequency "roll-off" is factory preset to 45Hz, for 60Hz operation, the frequency is 55Hz).

4.2 Voltage Adjustment

1. Adjust the front panel VOLT to vary the generator nominal voltage.
2. If used, a 1000 Ω 1 watt potentiometer may be connected to terminals EXT VR, refer to Figure4.

4.3 Stability Adjustment

1. Adjust the front panel STAB control the system stable.

2. Rotation of the front panel STAB control in the counter-clockwise (CCW) direction will speed response time If rotated too much for CCW, the generator voltage my oscillate (hunt).
3. Rotated the front panel STAB control CCW until the system start oscillating and then rotate cw just past the point where oscillation occurred.

5. FIELD FLASHING

When the regulator is operated with the generator for the first time, the polarity of residual magnetism may be reversed or too small to achieve the necessary build-up voltage for the regulator. If reversing the field connections does not induce build-up, and the residual voltage is less than the specified value of 5 Vac, shut down the Prime-mover and proceed with the following steps :

1. With the Prime-mover at rest and the regulator's field output wires disconnected, apply a DC source (NOT grounded) of not more than 3-12 Vdc with Positive to F+ and Negative to F-, in series with a current-limiting resistor of 3-5 ohms 20 watt. (The set battery is a suitable source.)
2. Allow approximately 3 seconds before removing the DC source.
3. With the voltage regulator disconnected (wires 3 and 4), start the prime mover and measure the " residual " voltage available at the auxiliary winding. If this voltage is greater than 5 Vac, reconnect voltage regulator, and voltage build-up should be successful. If less than 5 Vac is measured, repeat field flashing procedure.
4. If repeating steps a. and b. does not result in generator voltage build-up, and residual is greater than 5 Vac, replace voltage regulator.

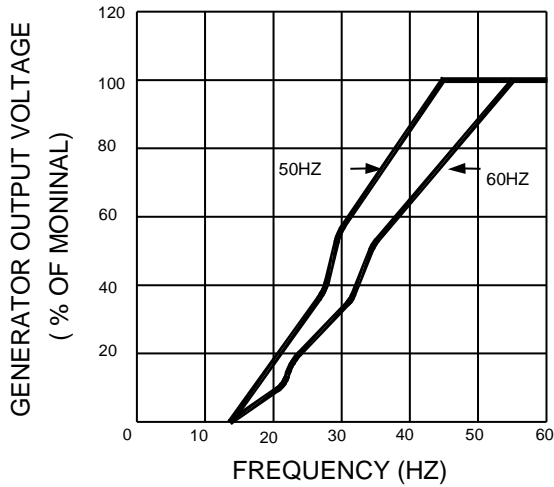
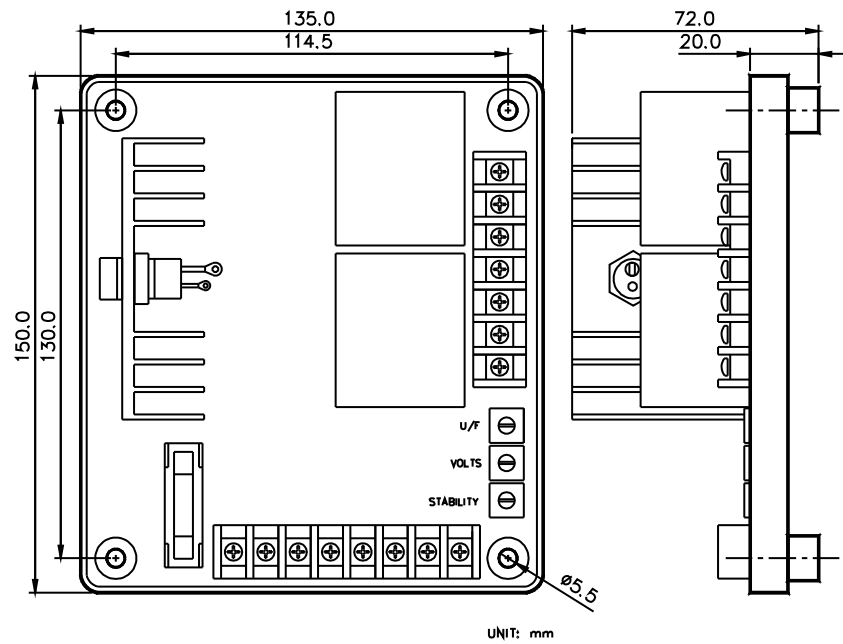

Frequency compensation curves
Figure 2

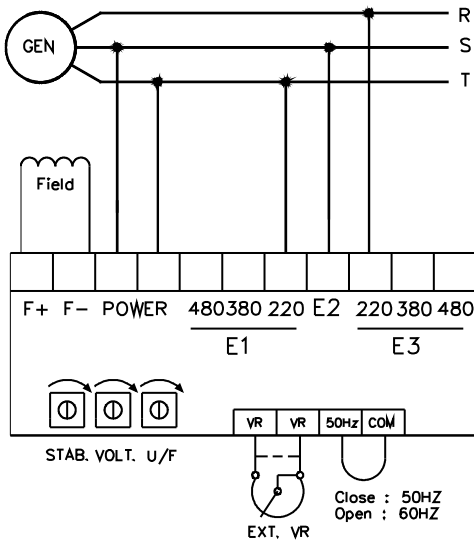
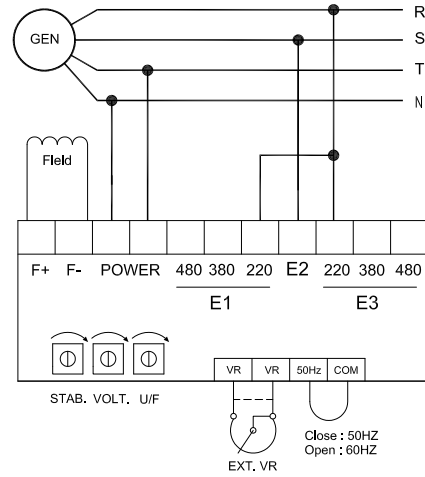

Wiring Diagram
Figure 4

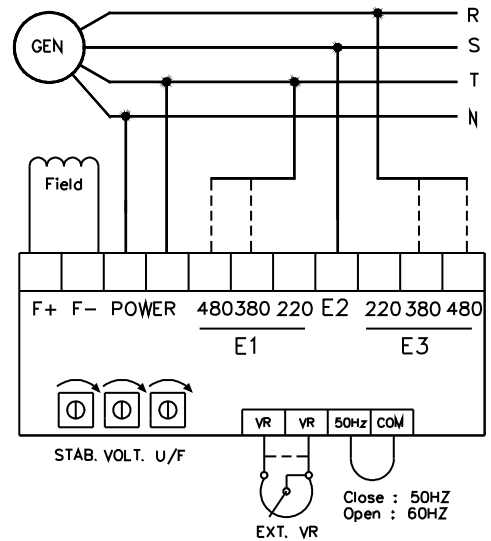

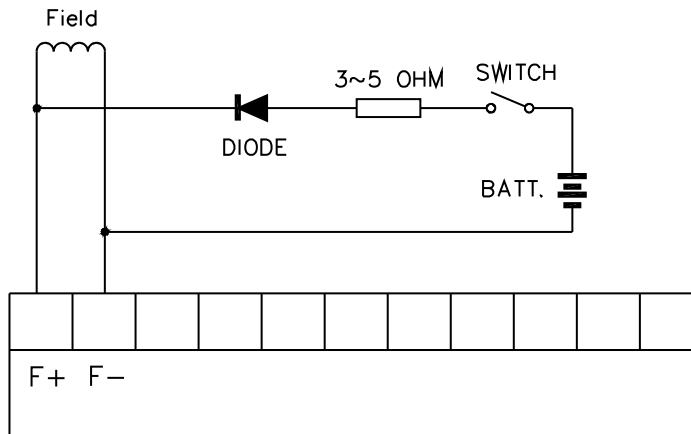

Flash with Battery
Figure 5

6. TROUBLE SHOOTING

SYMPTOM	CAUSE	CORRECTION
Voltage does not build up	Residual voltage below 5VAC	Flash generator field with proper method
	Incorrect wiring	Check wiring diagram for proper connection
	Power/sensing or field wires not connected	Connect the wires properly
	Generator not up to speed	Increase generator speed
	Over-excitation	Restart the generator
Out voltage low	Poor adjustment is made	Read start procedure carefully and adjust again
	Frequency roll-off	Increase generator speed
	Incorrect voltage selection	Read user's manual to select correct voltage
Out voltage high	Poor adjustment is made	Read start procedure carefully and adjust again
	Incorrect voltage selection	Read user's manual to select correct voltage
Out voltage instable	Poor adjustment is made	Read start procedure carefully and adjust again
	Field voltage requirement lower the rang of regulator	Inquire our distributor to solve

P.S. Please use the fuse of the original plant.

